

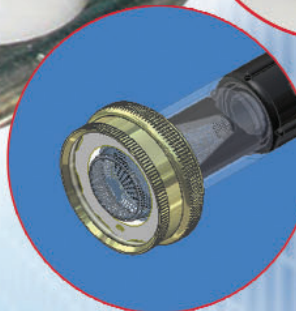

# JASON

## APPLIANCE PARTS & ACCESSORIES

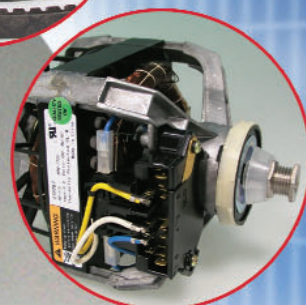
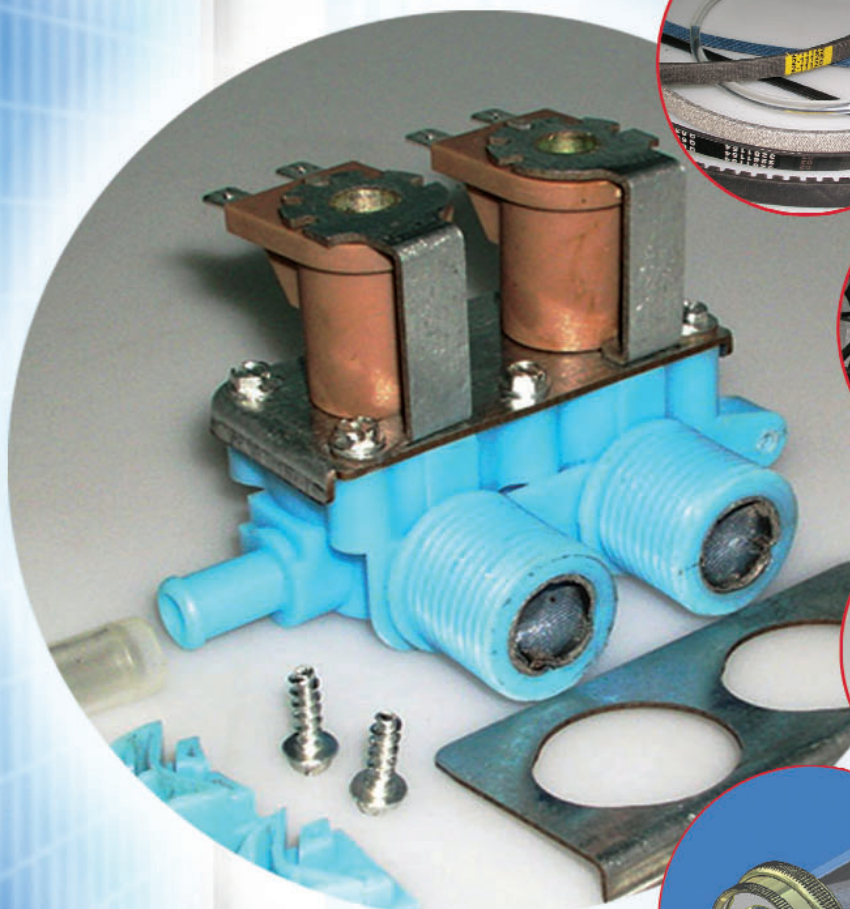

INNOVATIONS

## TABLE OF CONTENTS

Product Type	Page
Belts	2 - 8
Laundry Parts X-Reference	8 - 9
Dryer Parts	10 - 12
Motors	13
Washer Parts	14 - 19
Inlet Hose	19 - 21
Drain Hose - PVC	22
Drain Hose - Rubber	23
Garbage Disposal Parts	23

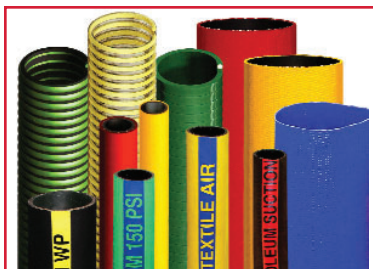
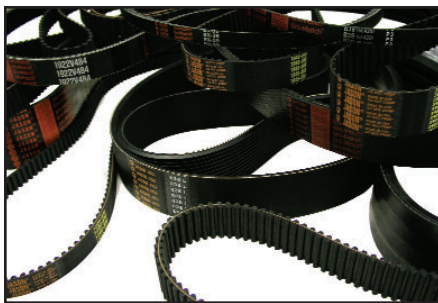

### Jason Industrial Also Offers a Full Line of Belting

- Synchronous Neoprene Timing Belts
- Urethane Belts
- Variable Speed V-Belts
- Metric Belts
- Multi-Rib V-Belts
- Double Multiple V-Belts
- MXV Super Duty Belts
- 400 Flat and Neoflex Belts

Jason Also Supplies a Full-Line of Hose & Couplings Products and Light & Heavy Duty Sheaves & Bushings  
See Inside Back Cover for a Complete Catalog Listing



### Be Sure to Check Out Jason's New Website!

- Online Ordering
- Product Information
- Corporate & Warehouse Locations Throughout the U.S. & Internationally
- Jason News, Including Information on New & Current Jason Products

[www.jasonindustrial.com](http://www.jasonindustrial.com)

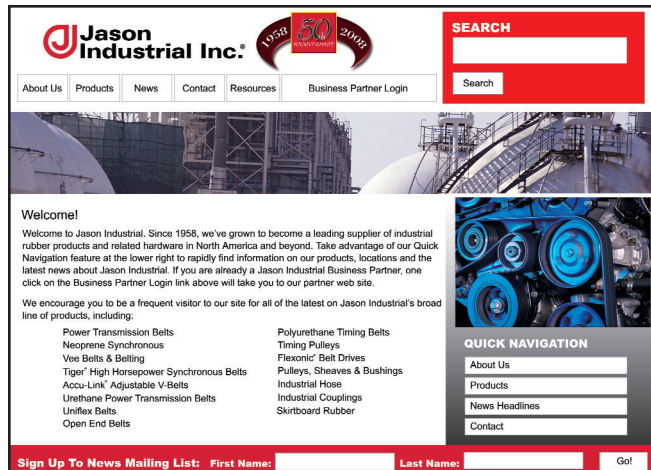

The screenshot shows the website's header with the logo, a 50th Anniversary badge (1958-2008), and navigation links: About Us, Products, News, Contact, Resources, Business Partner Login. A search bar is located in the top right corner.

The main content area features a large image of industrial machinery and a 'Welcome!' message. Below the message is a list of products including Power Transmission Belts, Neoprene Synchronous Vee Belts & Belting, Tiger High Horsepower Synchronous Belts, Accu-Link Adjustable V-Belts, Urethane Power Transmission Belts, Uniflex Belts, Open End Belts, Polyurethane Timing Belts, Timing Pulleys, Flexion Belt Drives, Pulleys, Sheaves & Bushings, Industrial Hose, Industrial Couplings, and Skirtboard Rubber.

A 'QUICK NAVIGATION' sidebar on the right contains links for About Us, Products, News Headlines, and Contact. At the bottom, there is a 'Sign Up To News Mailing List' form with fields for First Name, Last Name, and a Go! button.



## WV-1\*

**The Most Universal  
Washing Machine Water  
Valve In the Industry!**

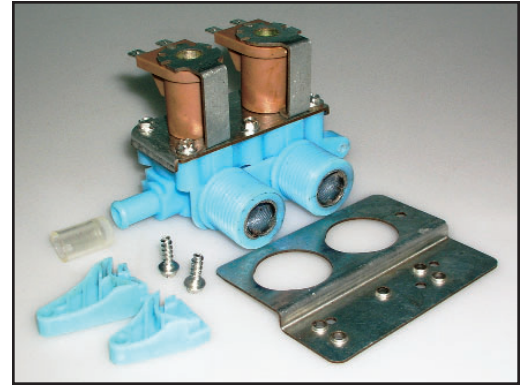

- Fits both old and new style valves.
- Replaces over 39 valves with one part!
- Replaces multiple OEM's.

EATON	ELECTROLUX	G.E.	HORTON	MAYTAG	WHIRLPOOL
CW151	134211400	WH13X10024	343	205613	285805
CW154		WH13X58	525	21001932	358276
CW50		WH13X59	526	22002360	358277
CW51		WH13X60	639	33-0085	358992
		WH13X66	325P	33-7044	363425
		WH13X71		33-7045	370067
		WH13X72		43-0219	388328
		WH13X75			4160143
		WH13X76			4160544
		WH13X78			4170695
	WH13X81				

\*Jason Industrial Inc. 2007 - Patent Pending

Rotating solenoid brackets allow you to position the solenoid to where you need them.

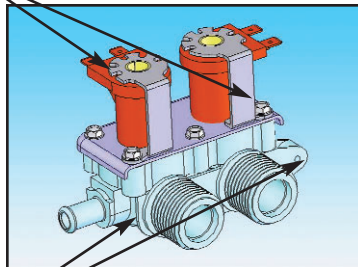

Mounting screw and grooves, allows valve to easily install into newer machines.

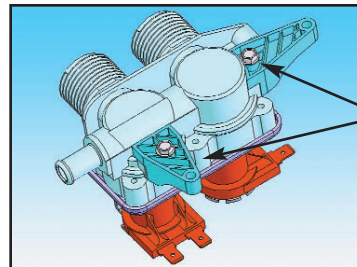

Screw on mounting tabs adapts valve to fit G.E. applications.

Screw on bracket with multiple mounting holes, fits most older style valves.

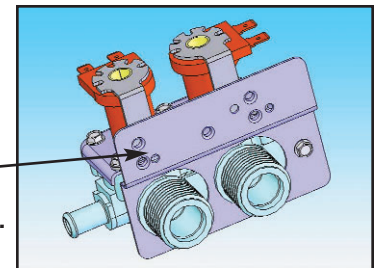

# LAUNDRY BELTS TYPES & IDENTIFICATION

## POLY-V DRYER BELTS

Used in most clothes dryers, Poly-V belts offer gripping power and tracking ability at longer lengths to fit around the drum. A Poly-V belt is capable of running on small pulleys and can withstand backside tensioning or idler.

- **Length** - Measure the outside diameter of the belt. This is best done with a flexible tape measure or belt measuring tool.
- **Identify the Rib Type** - Dryer belts are generally "H" or "J" rib Poly-V belts.



<b>"H" Rib</b>	-	<b>A - 3/25"</b>
		<b>B - 1/16"</b>
<hr/>		
<b>"J" Rib</b>	-	<b>A - 5/32"</b>
		<b>B - 3/32"</b>

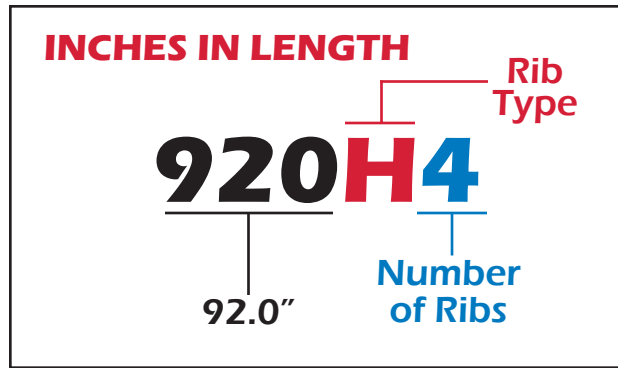

- **Count the Ribs**
- **Use Jason size cross-reference to determine the proper belt**

## POLY-V FLEXONIC® BELTS

Used primarily on front load washing machines, these special Poly-V belts are designed specific to the machine. A Flexonic® belt is stretched over the pulleys during installation and actually contracts while operating, eliminating the need for idler pulleys or tensioning.

Use only belts specified for the machine.

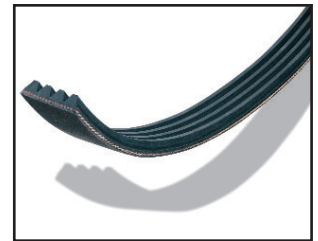

## ROUND BELTS

Used primarily on older dryers and Maytag Dishwashers, round belts are a Urethane material, sized and specifically matched to the machine.

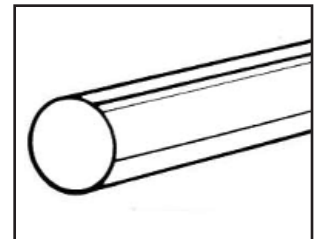

## FLAT BELTS

Flat belts are used due to their flexibility on small diameter pulleys and ability for a backside idler. The flat surface area gives excellent horsepower transfer on large surfaces like a dryer drum.

Electrolux 5303281154 is the industry's only flat belt.



\*Flexonic is a registered trademark of Hutchinson.

# IDENTIFYING WASHING MACHINE V-BELTS

**NOTE:** Most washing machine belts are custom designed to the machine. Several belts like 95405 and 2-11125 require special sizes. In addition, several belts are custom designed to run on back side idler pulleys or are designed to slip, allowing ramp up (use as a clutch). Due to this, obtaining the product model number or belt part number is the preferred method of identification.

Some commercial machines use standard V belts - use the Jason cross-reference guide to identify these belts.

## PART NUMBER SYSTEM

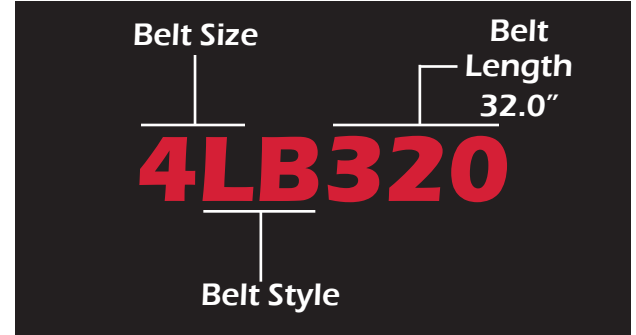

### 1. Identify the brand of the appliance.

### 2. Identify the belt style:

- LB - Bareback
- L - Wrapped
- MA - Flexonic (flat) with metric sizes
- MXV - Clutching
- SPZ - Metric size
- X - Cogged
- RL - Laminated

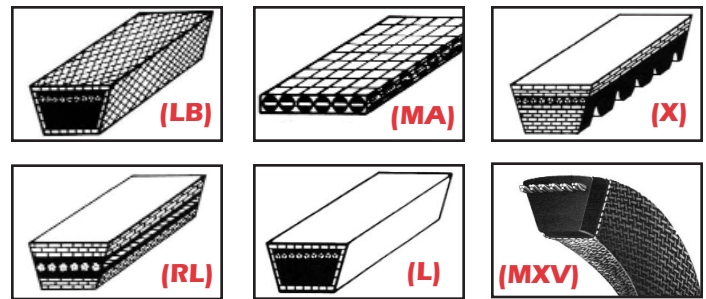

### 3. Identify the belt size:

- 3VX - used on commercial laundry
- 5VX - used on commercial laundry
- 4L - used on commercial & domestic laundry
- A - used on commercial laundry
- 5L - used on commercial laundry
- B - used on commercial laundry
- AX - Cogged belt used on commercial laundry
- BX - Cogged belt used on commercial laundry

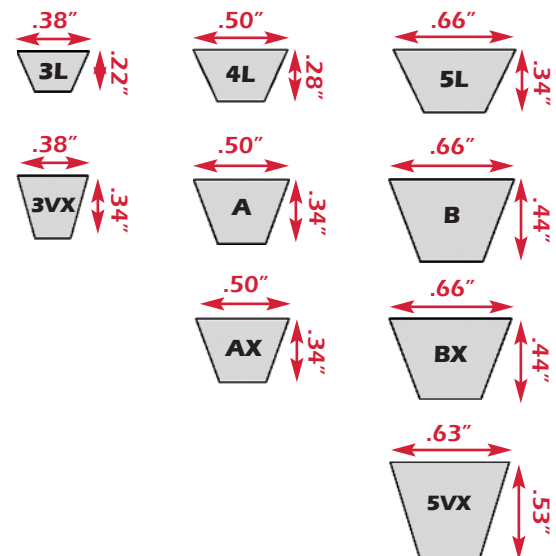

### 4. Measure length using a flexible tape measure or belt measuring tool:

- A & B belts are measured from the inside diameter
- 4L & 5L belts are measured from the inside diameter

AMERICAN DRYER COMPANY (ADC) • ALLIANCE • AMANA • SQ • UNIMAC				ALLIANCE • AMANA • SQ • UNIMAC			
OEM	PART NO.	JASON PART NO.	SIZE	OEM	PART NO.	JASON PART NO.	SIZE
ADC	100100	<b>B63/5L660</b>	5L660	Alliance, Amana, SQ	M400608	<b>M400608</b>	A76
ADC	100101	<b>A46/4L480</b>	4L480	Alliance, Amana, SQ	M401182	<b>M401182</b>	A65
ADC	100102	<b>3VX740</b>	3VX740	Alliance, Amana, SQ	M406386	<b>M406386</b>	4X630
ADC	100103	<b>A49/4L510</b>	4L510	Alliance, Amana, SQ	M411814	<b>M411814</b>	A77
ADC	100104	<b>A68</b>	A68	Alliance, Amana, SQ	ST128	<b>M400607</b>	A64
ADC	100105	<b>A50/4L520</b>	4L520	Alliance, Amana, SQ	ST128-1	<b>M400608</b>	A76
ADC	100106	<b>B66/5L690</b>	5L690	Alliance, Amana, SQ	TT128	<b>M401182</b>	A65
ADC	100107	<b>B64/5L670</b>	5L670	Alliance, SQ, Unimac	17558	<b>56095</b>	940J4
ADC	100108	<b>B65/5L680</b>	5L680	Alliance, SQ, Unimac	200063	<b>27001006</b>	4LB297
ADC	100109	<b>A63/4L650</b>	4L650	Alliance, SQ, Unimac	20185	<b>20185X</b>	4X280
ADC	100110	<b>A48/4L500</b>	4L500	Alliance, SQ, Unimac	20185X	<b>20185X</b>	4X280
ADC	100111	<b>B62/5L650</b>	5L650	Alliance, SQ, Unimac	20186	<b>20186X</b>	4X365
ADC	100114	<b>A61/4L630</b>	4L630	Alliance, SQ, Unimac	20186X	<b>20186X</b>	4X365
ADC	100116	<b>A65/4L670</b>	4L670	Alliance, SQ, Unimac	23758X	<b>23758X</b>	3X365
ADC	100117	<b>A60/4L620</b>	4L620	Alliance, SQ, Unimac	23759X	<b>23759X</b>	3X280
ADC	100118	<b>B28/5L310</b>	5L310	Alliance, SQ, Unimac	27001006	<b>27001006</b>	4LB297
ADC	100119	<b>B29/5L320</b>	5L320	Alliance, SQ, Unimac	27001007	<b>27001007</b>	4LB308
ADC	100120	<b>BX56</b>	BX56	Alliance, SQ, Unimac	27155X	<b>27155X</b>	3X224
ADC	100122	<b>BX84</b>	BX84	Alliance, SQ, Unimac	27246	<b>28808</b>	4LB330
ADC	100123	<b>BX80</b>	BX80	Alliance, SQ, Unimac	280304	<b>3V900</b>	3V900
ADC	100124	<b>BX53</b>	BX53	Alliance, SQ, Unimac	280307	<b>B48</b>	B48
ADC	100128	<b>BX50</b>	BX50	Alliance, SQ, Unimac	280309	<b>BX100</b>	BX100
ADC	100129	<b>BX94</b>	BX94	Alliance, SQ, Unimac	280319	<b>3V335</b>	3V335
ADC	100135	<b>A74</b>	A74	Alliance, SQ, Unimac	280337	<b>3V710</b>	3V710
ADC	100136	<b>BX95</b>	BX95	Alliance, SQ, Unimac	280338	<b>B43</b>	B43
ADC	100137	<b>A91</b>	A91	Alliance, SQ, Unimac	280341	<b>3V850</b>	3V850
ADC	100138	<b>A30</b>	A30	Alliance, SQ, Unimac	280342	<b>3V830</b>	3V830
ADC	100139	<b>R120J12</b>	R120J12	Alliance, SQ, Unimac	280343	<b>3V730</b>	3V730
ADC	100140	<b>BX38</b>	BX38	Alliance, SQ, Unimac	280351	<b>3V355</b>	3V355
ADC	100142	<b>BX42</b>	BX42	Alliance, SQ, Unimac	280352	<b>3VX315</b>	3VX315
ADC	100143	<b>A29</b>	A29	Alliance, SQ, Unimac	280353	<b>BX96</b>	BX96
ADC	100144	<b>A40/4L420</b>	4L420	Alliance, SQ, Unimac	280354	<b>B86</b>	B86
ADC	100145	<b>BX32</b>	BX32	Alliance, SQ, Unimac	280355	<b>BX108</b>	BX108
ADC	100149	<b>BX44</b>	BX44	Alliance, SQ, Unimac	280357	<b>BX93</b>	BX93
ADC	100151	<b>AX54</b>	AX54	Alliance, SQ, Unimac	280359	<b>BX90</b>	BX90
ADC	100152	<b>AX25</b>	AX25	Alliance, SQ, Unimac	280363	<b>3VX830</b>	3VX830
ADC	100156	<b>B30/5L330</b>	5L330	Alliance, SQ, Unimac	280368	<b>5VX1320</b>	5VX1320
ADC	100157	<b>BX36</b>	BX36	Alliance, SQ, Unimac	280405	<b>AX37</b>	AX37
ADC	100158	<b>A53/4L550</b>	4L550	Alliance, SQ, Unimac	280406	<b>3V630</b>	3V630
ADC	100159	<b>BX61</b>	BX61	Alliance, SQ, Unimac	286284	<b>M400315</b>	522J4
ADC	100160	<b>AX26</b>	AX26	Alliance, SQ, Unimac	28808	<b>28808</b>	4LB330
ADC	100161	<b>BX47</b>	BX47	Alliance, SQ, Unimac	37820	<b>27001007</b>	4LB308
ADC	100164	<b>BX51</b>	BX51	Alliance, SQ, Unimac	380331	<b>BX118</b>	BX118
ADC	100165	<b>A59/5L610</b>	5L610	Alliance, SQ, Unimac	38174	<b>27001006</b>	4LB297
ADC	100166	<b>A77/4L790</b>	4L790	Alliance, SQ, Unimac	3967X	<b>3967X</b>	4X320
ADC	100168	<b>A34/5L360 (2)</b>	5L360	Alliance, SQ, Unimac	4001501	<b>40111201</b>	935H5
ADC	100169	<b>A32/5L350 (2)</b>	5L350	Alliance, SQ, Unimac	40111201	<b>40111201</b>	935H4
ADC	100170	<b>3VX710</b>	3VX710	Alliance, SQ, Unimac	510178	<b>40111201</b>	935H4
ADC	100171	<b>A42/4L440</b>	4L440	Alliance, SQ, Unimac	511255	<b>40111201</b>	935H5
ADC	100172	<b>BX66</b>	BX66	Alliance, SQ, Unimac	51994X	<b>51994X</b>	3X465
ADC	100173	<b>950J12</b>	950J12	Alliance, SQ, Unimac	52556	<b>52556</b>	980J4
ADC	100174	<b>AX53</b>	AX53	Alliance, SQ, Unimac	55059	<b>55059</b>	650J3
ADC	100175	<b>AX55</b>	AX55	Alliance, SQ, Unimac	55060	<b>312512</b>	4R740
ADC	100178	<b>A55/4L570</b>	4L570	Alliance, SQ, Unimac	56095	<b>56095</b>	940J4
ADC	100180	<b>B31/5L340</b>	5L340	Alliance, SQ, Unimac	661570	<b>40111201</b>	935H4
ADC	100182	<b>B27/5L300</b>	5L300	Alliance, SQ, Unimac	F0280379-00	<b>BX128</b>	BX128
ADC	100183	<b>B26/5L290</b>	5L290	Alliance, SQ, Unimac	F0280379-00A	<b>BX128</b>	BX128
ADC	100184	<b>BX63</b>	BX63	Alliance, SQ, Unimac	F200140300	<b>3/R3VX1120</b>	3/R3VX1120
ADC	100185	<b>B75/5L780</b>	5L780	Alliance, SQ, Unimac	F200140400	<b>3/R3VX1180</b>	3/R3VX1180
ADC	100189	<b>B61/5L640</b>	5L640	Alliance, SQ, Unimac	F200196400	<b>BX120</b>	BX120
ADC	100190	<b>AX51</b>	AX51	Alliance, SQ, Unimac	F280304	<b>3V900</b>	3V900
ADC	100193	<b>BX45</b>	BX45	Alliance, SQ, Unimac	F280307	<b>B48</b>	B48
ADC	100194	<b>A69/4L720</b>	4L720	Alliance, SQ, Unimac	F280309	<b>BX100</b>	BX100
ADC	102407	<b>2621JP6</b>	2621JP6	Alliance, SQ, Unimac	F280321	<b>3V800</b>	3V800
ADC	102415	<b>3338J15MA</b>	3338J15MA	Alliance, SQ, Unimac	F280337	<b>3V710</b>	3V710
Alliance, Amana, SQ	59174	<b>59174</b>	935H4	Alliance, SQ, Unimac	F280338	<b>B43</b>	B43
Alliance, Amana, SQ	M400607	<b>M400607</b>	A64	Alliance, SQ, Unimac	F280341	<b>3V850</b>	3V850



# APPLIANCE BELTS

ALLIANCE • SQ • UNIMAC • AMETEK • BLACKSTONE • BROCK EXTRACTOR • CISSEL • DEXTER/IPSO				DEXTER/IPSO • ELECTROLUX			
OEM	PART NO.	JASON PART NO.	SIZE	OEM	PART NO.	JASON PART NO.	SIZE
Alliance, SQ, Unimac	F280342	<b>3V830</b>	3V830	Dexter/IPSO	9040-077-001	<b>A52</b>	A52
Alliance, SQ, Unimac	F280343	<b>3V730</b>	3V730	Dexter/IPSO	A67	<b>A67</b>	A67
Alliance, SQ, Unimac	F280351	<b>3V355</b>	3V355	Dexter/IPSO	AX71	<b>AX71</b>	AX71
Alliance, SQ, Unimac	F280352	<b>3VX315</b>	3VX315	Dexter/IPSO	SPZ1862	<b>SPZ1862</b>	SPZ1862
Alliance, SQ, Unimac	F280353	<b>BX96</b>	BX96	Electrolux	11-111	<b>5308057424</b>	920J4
Alliance, SQ, Unimac	F280354	<b>B86</b>	B86	Electrolux	131130700	<b>WE12X82</b>	878HY
Alliance, SQ, Unimac	F280355	<b>BX108</b>	BX108	Electrolux	131234000	<b>134161100</b>	4LB325
Alliance, SQ, Unimac	F280357	<b>BX93</b>	BX93	Electrolux	131276300	<b>134051000</b>	1460J6MA
Alliance, SQ, Unimac	F280359	<b>BX90</b>	BX90	Electrolux	131553800	<b>WE12X82</b>	878H4
Alliance, SQ, Unimac	F280366	<b>R870J6</b>	R870J6	Electrolux	131654	<b>5308057424</b>	912J3
Alliance, SQ, Unimac	F280367	<b>3VX1120</b>	3VX1120	Electrolux	131686100	<b>131686100</b>	4L320
Alliance, SQ, Unimac	F280368	<b>5VX1320</b>	5VX1320	Electrolux	134051000	<b>134051000</b>	1460J6MA
Alliance, SQ, Unimac	F280368	<b>R785J4</b>	5VX1320	Electrolux	134161100	<b>134161100</b>	4LB325
Alliance, SQ, Unimac	F280369	<b>R820J6</b>	R820J6	Electrolux	134163400	<b>WE12X82</b>	878H4
Alliance, SQ, Unimac	F280370	<b>R690J4</b>	R690J4	Electrolux	134163500	<b>134163500</b>	895H4
Alliance, SQ, Unimac	F280405	<b>AX37</b>	AX37	Electrolux	134503600	<b>WE12X82</b>	WE12X82
Alliance, SQ, Unimac	F280406	<b>3V630</b>	3V630	Electrolux	134503900	<b>134163500</b>	895H4
Alliance, SQ, Unimac	HT128	<b>A43</b>	A43	Electrolux	134511600	<b>134161100</b>	4L325BB
Alliance, SQ, Unimac	LT128	<b>M400315</b>	522J4	Electrolux	136102	<b>5303161099</b>	810J3
Alliance, SQ, Unimac	M400315	<b>M400315</b>	522J4	Electrolux	139318	<b>5308001832</b>	3LB315
Alliance, SQ, Unimac	R0606524	<b>56095</b>	940J4	Electrolux	140801	<b>5308057424</b>	920J4
Alliance, SQ, Unimac	R0606539	<b>28808</b>	4LB330	Electrolux	141297	<b>5308057424</b>	920J4
Alliance, SQ, Unimac	R0606549	<b>40111201</b>	935H4	Electrolux	143056	<b>5303281154</b>	50F88
Ametek	66-2787	<b>A88</b>	6L900	Electrolux	144667	<b>134161100</b>	4LB320
Ametek	66-2788	<b>AX33</b>	AX33	Electrolux	145221	<b>5303281154</b>	50F88
Ametek	66-2790	<b>AX51</b>	AX51	Electrolux	145371	<b>134161100</b>	4LB320
BLACKSTONE	11190	<b>23759X</b>	3X280	Electrolux	148270	<b>WE12X82</b>	878H4
BLACKSTONE	25352	<b>2-11124</b>	3L410	Electrolux	148271	<b>134163500</b>	895H4
BLACKSTONE	25438	<b>2-11125</b>	2-11125	Electrolux	1500202	<b>5303280326</b>	4LB320
BLACKSTONE	26122	<b>26122</b>	7R558	Electrolux	2834353	<b>2834353</b>	3X310
Brock Extractor	2157	<b>B60</b>	B60	Electrolux	3004909	<b>5308057424</b>	912J3
Brock Extractor	2400-157-2	<b>B62</b>	B62	Electrolux	3161099	<b>5303161099</b>	810J3
Brock Extractor	5459	<b>B59</b>	B59	Electrolux	3161152	<b>134161100</b>	4LB320
Brock Extractor	5461	<b>B61</b>	B61	Electrolux	3203018	<b>134051000</b>	1460J6MA
CISSEL	TU10196	<b>A34</b>	4L36	Electrolux	3204314	<b>3204314</b>	50F88
CISSEL	TU10197	<b>A60</b>	4L62	Electrolux	3204418	<b>131686100</b>	4L320
CISSEL	TU1034	<b>A64</b>	A64	Electrolux	3261151	<b>5303261151</b>	4L470
CISSEL	TU11034	<b>M400607</b>	A64	Electrolux	3261153	<b>5303261153</b>	4RL535
CISSEL	TU11035	<b>A57</b>	4L59	Electrolux	3261155	<b>5303261155</b>	3RL415
CISSEL	TU12570	<b>A54</b>	4L56	Electrolux	3280323	<b>134161100</b>	4LB325
CISSEL	TU12643	<b>A63</b>	4L65	Electrolux	3280326	<b>5303280326</b>	4LB320
CISSEL	TU14716	<b>A27</b>	4L29	Electrolux	3281154	<b>5303281154</b>	50F88
CISSEL	TU15205	<b>A44</b>	4L46	Electrolux	3283287	<b>134163500</b>	895H4
CISSEL	TU15206	<b>A46</b>	4L48	Electrolux	5300639357	<b>5303161099</b>	810J3
CISSEL	TU15515	<b>B45</b>	B45	Electrolux	5302834353	<b>2834353</b>	3X310
CISSEL	TU1954	<b>A28</b>	4L30	Electrolux	5303161099	<b>5303161099</b>	810J3
CISSEL	TU2314	<b>A36</b>	4L38	Electrolux	5303276623	<b>5308027638</b>	780H4
CISSEL	TU2317	<b>A36</b>	4L38	Electrolux	5303280326	<b>5303280326</b>	4LB320
CISSEL	TU2363	<b>B47</b>	B47	Electrolux	5303283287	<b>134163500</b>	895H4
CISSEL	TU3393	<b>20185X</b>	4X280	Electrolux	5303283471	<b>134163500</b>	878H4
CISSEL	TU3394	<b>A48</b>	4L50	Electrolux	5307537239	<b>5307537239</b>	890J4
CISSEL	TU3395	<b>A56</b>	4L58	Electrolux	5308001832	<b>5308001832</b>	3LB315
CISSEL	TU3472	<b>A50</b>	4L52	Electrolux	5308002451	<b>134161100</b>	4LB325
CISSEL	TU4794	<b>A57</b>	4L59	Electrolux	5308006498	<b>5308006498</b>	3LB320
CISSEL	TU5447	<b>A64</b>	4L66	Electrolux	5308011289	<b>5308001832</b>	3LB315
CISSEL	TU5638	<b>A53</b>	4L55	Electrolux	5308011289	<b>5308001832</b>	3LB315
CISSEL	TU6190	<b>A37</b>	4L39	Electrolux	5308027638	<b>5308027638</b>	780H4
CISSEL	TU6725	<b>A58</b>	4L60	Electrolux	5308057424	<b>5308057424</b>	920J4
CISSEL	TU7021	<b>A55</b>	4L57	Electrolux	638806	<b>2834353</b>	3X310
CISSEL	TU8930	<b>TU8930</b>	1200J10	Electrolux	638957	<b>5300638957</b>	904J4
CISSEL	TU8930	<b>TU8930</b>	1200J10	Electrolux	639357	<b>5303161099</b>	810J3
Dexter/IPSO	9040-073-009	<b>B53</b>	B53	Electrolux	7537239	<b>5307537239</b>	890J4
Dexter/IPSO	9040-076-004	<b>AX61</b>	AX61	Electrolux	8001651	<b>5308057424</b>	920J4
Dexter/IPSO	9040-076-005	<b>BX71</b>	BX71	Electrolux	8001832	<b>5308001832</b>	3LB315
				Electrolux	8002451	<b>134161100</b>	4LB325
				Electrolux	8004064	<b>5303280326</b>	4LB320
				Electrolux	8006498	<b>5308006498</b>	3LB320

<b>ELECTROLUX • GE</b>				<b>GEMLINE</b>			
OEM	PART NO.	JASON PART NO.	SIZE	OEM	PART NO.	JASON PART NO.	SIZE
Electrolux	8011289	<b>5308001832</b>	3LB315	Gemline	LB111	<b>5308001832</b>	3LB315
Electrolux	8015096	<b>5303261151</b>	A45	Gemline	LB113	<b>134161100</b>	4LB320
Electrolux	8015132	<b>5303261155</b>	3L415	Gemline	LB117	<b>134161100</b>	4LB325
Electrolux	8015133	<b>5303261153</b>	4L535	Gemline	LB120	<b>WH1X2026</b>	4L300
Electrolux	8027638	<b>5308027638</b>	780H4	Gemline	LB125	<b>2-11124</b>	3L410
Electrolux	8057424	<b>5308057424</b>	912J3	Gemline	LB126	<b>2-11125</b>	2-11125
Electrolux	F131324	<b>5303280326</b>	4LB320	Gemline	LB127	<b>2K11124/25</b>	Set
Electrolux	F131602	<b>5303280326</b>	4LB320	Gemline	LB131	<b>35-0465</b>	SPZ1080
Electrolux	F131654	<b>5308057424</b>	920J4	Gemline	LB131	<b>35-0465</b>	SPZ1080
Electrolux	F133171	<b>5303280326</b>	4LB320	Gemline	LB132	<b>21352320</b>	SPZ1295
Electrolux	F139318	<b>5308001832</b>	3LB315	Gemline	LB138	<b>23758X</b>	3X365
Electrolux	F141297	<b>5308057424</b>	920J4	Gemline	LB140	<b>27155X</b>	3X224
Electrolux	F61618	<b>WE12X5009</b>	3L320	Gemline	LB142	<b>28808</b>	4LB330
Electrolux	F63510	<b>5300063510</b>	895J3	Gemline	LB143	<b>23759X</b>	3X280
Electrolux	F73382	<b>5308057424</b>	920J4	Gemline	LB150	<b>5303261151</b>	4L470
Electrolux	F78448	<b>5308027638</b>	780H4	Gemline	LB151	<b>5303261155</b>	3RL415
Electrolux	F78794	<b>5303280326</b>	4LB320	Gemline	LB151	<b>5303261155</b>	3RL415
Electrolux	Q12967	<b>5303261155</b>	3L415	Gemline	LB152	<b>5308006498</b>	3LB320
Electrolux	Q12969	<b>5303261155</b>	3L415	Gemline	LB152	<b>5308006498</b>	3LB320
Electrolux	Q12970	<b>5303261151</b>	4L470	Gemline	LB154	<b>5303261153</b>	4RL535
Electrolux	Q181621	<b>5308006498</b>	3LB320	Gemline	LB154	<b>5303261153</b>	4RL535
Electrolux	Q181624	<b>5308006498</b>	3LB320	Gemline	LB155	<b>5300622451</b>	3LB330
Electrolux	Q181625	<b>5308001832</b>	3LB315	Gemline	LB157	<b>134161100</b>	4L320
Electrolux	Q607581	<b>134051000</b>	1460J6MA	Gemline	LB160	<b>95405</b>	4LX475
Electrolux	Q62144	<b>5303261153</b>	4L535	Gemline	LB161	<b>96388</b>	7MR1220
Electrolux	Q62149	<b>5303261155</b>	3L415	Gemline	LB174	<b>3934700</b>	3RL4700
Electrolux	Q62152	<b>5303261153</b>	4L535	Gemline	LB175	<b>27001007</b>	4LB308
Electrolux	Q622451	<b>5300622451</b>	3LB330	Gemline	LB175	<b>27001007</b>	4LB308
Electrolux	Q63259	<b>5308006498</b>	3LB320	Gemline	LB201	<b>5300638957</b>	904J4
Electrolux	Q63805	<b>5303281154</b>	50F88	Gemline	LB202	<b>5303161099</b>	810J3
Electrolux	Q63806	<b>5303281154</b>	50F88	Gemline	LB204	<b>5307537239</b>	890J4
Electrolux	Q63807	<b>5303281154</b>	50F88	Gemline	LB210	<b>5308057424</b>	920J4
Electrolux	Q63808	<b>5303281154</b>	50F88	Gemline	LB212	<b>5300063510</b>	895J3
Electrolux	Q63809	<b>5303281154</b>	50F88	Gemline	LB215	<b>WE12X36</b>	877J3
Electrolux	Q63810	<b>5303281154</b>	50F88	Gemline	LB216	<b>WE12X82</b>	878H4
Electrolux	Q63812	<b>5303281154</b>	50F88	Gemline	LB216	<b>WE12X82</b>	878H4
GE	109B3872	<b>WE12X36</b>	877J3	Gemline	LB217	<b>WE12X49</b>	996J4
GE	109B4949	<b>WH1X2026</b>	4L300	Gemline	LB217	<b>WE12X49</b>	996J4
GE	139C8152P	<b>WE12X49</b>	996J4	Gemline	LB218	<b>WE12X46</b>	681H3
GE	199B222	<b>5308027638</b>	776H4	Gemline	LB230	<b>311012</b>	3L470
GE	4400EL2001A	<b>341241</b>	920H4	Gemline	LB231	<b>311013</b>	3L565
GE	502023	<b>WH1X5089</b>	4X331	Gemline	LB232	<b>312512</b>	4R740
GE	521367	<b>WH1X5089</b>	4X331	Gemline	LB232	<b>312512</b>	4R740
GE	WE12M22	<b>134163500</b>	895H4	Gemline	LB234	<b>312959</b>	1000H5
GE	WE12M24	<b>5308027638</b>	776H4	Gemline	LB235	<b>312544</b>	770J3
GE	WE12X10001	<b>WE12X82</b>	E12X82	Gemline	LB236	<b>313328</b>	770H4
GE	WE12X10009	<b>WE12X82</b>	WE12X82	Gemline	LB237	<b>3K11012/13</b>	Set
GE	WE12X10011	<b>341241</b>	920H4	Gemline	LB241	<b>63-4793</b>	100J3
GE	WE12X34	<b>WE12X36</b>	877J3	Gemline	LB242	<b>63-4663</b>	1000J4
GE	WE12X36	<b>WE12X36</b>	877J3	Gemline	LB243	<b>63-4664</b>	1000J5
GE	WE12X42	<b>WE12X82</b>	878H4	Gemline	LB250	<b>51994X</b>	3X465
GE	WE12X43	<b>WE12X49</b>	996J4	Gemline	LB251	<b>52556</b>	980J4
GE	WE12X46	<b>WE12X46</b>	681H3	Gemline	LB254	<b>40111201</b>	935H4
GE	WE12X49	<b>WE12X49</b>	996J4	Gemline	LB254	<b>40111201</b>	935H4
GE	WE12X5009	<b>WE12X5009</b>	3L320	Gemline	LB255	<b>53-1512</b>	906H5
GE	WE12X51	<b>5308027638</b>	776H4	Gemline	LB260	<b>5303281154</b>	50F88
GE	WE12X79	<b>5308027638</b>	776H4	Gemline	LB270	<b>56095</b>	940J4
GE	WE12X82	<b>WE12X82</b>	878H4	Gemline	LB271	<b>691371</b>	8R900
GE	WE12X85	<b>5303161099</b>	810J3	Gemline	LB274	<b>337019</b>	940J3
GE	WE12X96	<b>WE12X36</b>	877J3	Gemline	LB275	<b>337388</b>	920J3
GE	WH1X10031	<b>WH1X2026</b>	4L300	Gemline	LB276	<b>341241</b>	920H4
GE	WH1X2026	<b>WH1X2026</b>	4L300	Gemline	LB278	<b>3394652</b>	790H4
GE	WH1X2788	<b>WH1X2788</b>	4L284	Gemline	LB278	<b>3394652</b>	790H4
GE	WH1X5089	<b>WH1X5089</b>	4X331	Gemline	LB279	<b>341241</b>	920H5
GE	WH7X113	<b>131686100</b>	4L320	Gemline	LB280	<b>356402</b>	580J4
GE	WH7X86	<b>134161100</b>	4LB325	Gemline	LB281	<b>14123W</b>	6R381
				Gemline	LB289	<b>234694</b>	3X580



# APPLIANCE BELTS

GEMLINE • HOOVER • HUEBSCH • IDC • MAYTAG				MAYTAG • MEILE • MILNOR • MONTGOMERY WARDS • WASCOMAT			
OEM	PART NO.	JASON PART NO.	SIZE	OEM	PART NO.	JASON PART NO.	SIZE
Gemline	LB291	<b>5308027638</b>	780H4	Maytag	40111201	<b>40111201</b>	935H4
Gemline	LB293	<b>8181670</b>	130J7MA	Maytag	43-0283	<b>35-0465</b>	SPZ1080
Gemline	LB294	<b>12001788</b>	1410J6MA	Maytag	53-0186	<b>341241</b>	920H4
Gemline	LB295	<b>134051000</b>	1460J6MA	Maytag	53-1080	<b>341241</b>	920H4
Gemline	LB297	<b>22003483</b>	SPZ1287	Maytag	53-1512	<b>53-1512</b>	906H5
Gemline	LB298	<b>134163500</b>	895H4	Maytag	53-1589	<b>341241</b>	925H4
Gemline	LB299	<b>9724037</b>	670J6MA	Maytag	53-2671	<b>341241</b>	920H4
Gemline	LB300	<b>5749920</b>	5JE1321MA	Maytag	53-2671	<b>341241</b>	920H4
Gemline	LB301	<b>5830920</b>	5JE1900MIE	Maytag	62608400	<b>22003483</b>	SPZ1287
Gemline	LB302	<b>27001006</b>	4LB297	Maytag	62706950	<b>62722870</b>	1410J6MA
Gemline	LB340	<b>40111201</b>	940H5	Maytag	62722870	<b>62722870</b>	1410J6MA
HOOVER	14123W	<b>14123W</b>	6R381	Maytag	63-1402	<b>63-4793</b>	100J3
HOOVER	716882	<b>716882</b>	2X240	Maytag	63-3161	<b>63-4663</b>	1000J4
Huebsch	H8753170H	<b>3VX425</b>	3VX425	Maytag	63-3862	<b>63-4663</b>	1000J4
Huebsch	H87532685	<b>3VX670</b>	3VX670	Maytag	63-4064	<b>63-4664</b>	1000J5
Huebsch	H87533816	<b>3VX950</b>	3VX950	Maytag	63-4164	<b>63-4664</b>	1000J5
Huebsch	M400315	<b>M400315</b>	M400315	Maytag	63-4663	<b>63-4663</b>	1000J4
Huebsch	M412090	<b>3VX530</b>	3VX530	Maytag	63-4664	<b>63-4664</b>	1000J5
IDC	DA402	<b>A48</b>	4L500	Maytag	63-4793	<b>63-4793</b>	100J3
IDC	DA403	<b>B62</b>	5L650	Maytag	63-4984	<b>63-4793</b>	100J3
IDC	DA404	<b>A74</b>	4L760	Maytag	63-5007	<b>63-4663</b>	1000J4
IDC	DA429	<b>B66</b>	5L690	Maytag	63700300	<b>349533</b>	920H5
Maytag	12001435	<b>62722870</b>	1410J6MA	Maytag	73-0028	<b>73-0028</b>	730H6
Maytag	12001788	<b>12001788</b>	1410J6MA	Maytag	78772	<b>902115</b>	7R620
Maytag	12002040	<b>62722870</b>	1410J6MA	Maytag	78772	<b>902115</b>	7R620
Maytag	12112425	<b>2K11124/25</b>	Set	Maytag	902115	<b>902115</b>	7R620
Maytag	162507	<b>162507</b>	6R381	Maytag	9-11197	<b>902115</b>	7R620
Maytag	2-11124	<b>2-11124</b>	3L410	Maytag	9-2115	<b>902115</b>	7R620
Maytag	2-11125	<b>2-11125</b>	2-11125	MEILE	5749920	<b>5749920</b>	5JE1321MA
Maytag	2-11451	<b>5303261155</b>	3L415	MEILE	5830920	<b>5830920</b>	5JE1900MIE
Maytag	21352320	<b>21352320</b>	SPZ1295	Milnor	54R003	<b>AX33</b>	AX33
Maytag	22002313	<b>22003483</b>	SPZ1287	Milnor	54R006	<b>A36</b>	A36
Maytag	22002709	<b>22003483</b>	SPZ1287	Milnor	54R006A	<b>AX36</b>	AX36
Maytag	22003483	<b>22003483</b>	SPZ1287	Milnor	54R006B	<b>AX37</b>	AX37
Maytag	251023	<b>251023</b>	3L360	Milnor	54R007	<b>A38</b>	A38
Maytag	2-51023	<b>251023</b>	3L360	Milnor	54R007B	<b>AX38</b>	AX38
Maytag	2K11124/25	<b>2K11124/25</b>	Set	Milnor	54R008	<b>AX35</b>	AX35
Maytag	311012	<b>311012</b>	3L470	Milnor	54R009G	<b>AX34</b>	AX34
Maytag	3-11012	<b>311012</b>	3L470	Milnor	54R010	<b>AX71</b>	AX71
Maytag	311013	<b>311013</b>	3L565	Milnor	54R012	<b>AX78</b>	AX78
Maytag	3-11013	<b>311013</b>	3L565	Milnor	54R110	<b>B39</b>	5L420
Maytag	312512	<b>312512</b>	4R740	Milnor	54T068	<b>BX35</b>	BX35
Maytag	3-12512	<b>312512</b>	4R740	MONT. WARDS	8066065	<b>341241</b>	920H5
Maytag	312544	<b>312544</b>	770J3	MONT. WARDS	85025694	<b>5303261153</b>	4L535
Maytag	3-12544	<b>312544</b>	770J3	MONT. WARDS	85216916	<b>5303280326</b>	4LB320
Maytag	312959	<b>312959</b>	1000H5	MONT. WARDS	85222090	<b>2-11124</b>	3L410
Maytag	3-12959	<b>312959</b>	1000H5	MONT. WARDS	85222104	<b>2-11125</b>	2-11125
Maytag	313328	<b>313328</b>	770H4	MONT. WARDS	85223232	<b>312959</b>	1000H5
Maytag	3-13328	<b>313328</b>	770H4	MONT. WARDS	85230352	<b>WE12X82</b>	878H4
Maytag	3-14774	<b>312959</b>	1000H5	MONT. WARDS	85231251	<b>WE12X46</b>	681H3
Maytag	31531589	<b>341241</b>	920H4	MONT. WARDS	85231278	<b>WE12X49</b>	996J4
Maytag	31534589	<b>341241</b>	920H4	MONT. WARDS	85235133	<b>WH1X2026</b>	4L300
Maytag	33001777	<b>349533</b>	920H5	MONT. WARDS	85237934	<b>312959</b>	1000H5
Maytag	33002535	<b>349533</b>	920H5	MONT. WARDS	85269208	<b>5303280326</b>	4LB320
Maytag	33-0388	<b>33-0388</b>	SPZ1077	MONT. WARDS	8528672	<b>5303280326</b>	4LB320
Maytag	33-6104	<b>35-0465</b>	SPZ1080	WASCOMAT	652167	<b>B93</b>	B93
Maytag	35-0425	<b>35-0465</b>	SPZ1080	WASCOMAT	770104	<b>3V450</b>	3V450
Maytag	35-0465	<b>35-0465</b>	SPZ1080	WASCOMAT	900556	<b>A74</b>	A74
Maytag	35-2320	<b>21352320</b>	SPZ1295	WASCOMAT	90056	<b>A78</b>	A78
Maytag	35-3662	<b>21352320</b>	SPZ1295	WASCOMAT	900637	<b>3V900</b>	3V900
Maytag	36-4378	<b>36-4378</b>	650J10	WASCOMAT	900662	<b>3V710</b>	3V710
Maytag	3700300	<b>62722870</b>	1410J6MA	WASCOMAT	900750	<b>3V750</b>	3V750
Maytag	3713880	<b>349533</b>	920H5	WASCOMAT	900762	<b>3V800</b>	3V800
Maytag	40053601	<b>27001006</b>	4LB297	WASCOMAT	903351	<b>3V850</b>	3V850
Maytag	40053607	<b>27001007</b>	4LB309	WASCOMAT	920505	<b>3V400</b>	3V400
				WASCOMAT	922547	<b>3V475</b>	3V475

	OEM	PART NO.	JASON PART NO.	SIZE		OEM	PART NO.	JASON PART NO.	SIZE
<b>WHIRLPOOL</b>	Whirlpool	16192	<b>95405</b>	4LX475	<b>WHIRLPOOL</b>	Whirlpool	341241	<b>341241</b>	920H4
	Whirlpool	16358	<b>95405</b>	4LX475		Whirlpool	345473	<b>349533</b>	920H5
	Whirlpool	19427	<b>234694</b>	3X580		Whirlpool	345675	<b>3394652</b>	790H4
	Whirlpool	217101	<b>95405</b>	4LX475		Whirlpool	349533	<b>349533</b>	920H5
	Whirlpool	234694	<b>234694</b>	3X580		Whirlpool	352967	<b>96388</b>	7MR1220
	Whirlpool	237555	<b>56095</b>	940J4		Whirlpool	356402	<b>356402</b>	580J4
	Whirlpool	238739	<b>691371</b>	8R900		Whirlpool	356403	<b>356402</b>	580J4
	Whirlpool	287371	<b>691371</b>	8R900		Whirlpool	3934700	<b>3934700</b>	3RL4700
	Whirlpool	296326	<b>691371</b>	8R900		Whirlpool	4319392	<b>3394652</b>	790H4
	Whirlpool	298422	<b>691371</b>	8R900		Whirlpool	4319392	<b>3394652</b>	790H4
	Whirlpool	313646	<b>313646</b>	.093X29.5"		Whirlpool	46197020089	<b>8181670</b>	130J7MA
	Whirlpool	317513	<b>3934700</b>	3L4700		Whirlpool	660996	<b>349533</b>	920H5
	Whirlpool	337019	<b>337019</b>	940J3		Whirlpool	660997	<b>349533</b>	920H5
	Whirlpool	337388	<b>337388</b>	920J3		Whirlpool	661561	<b>349533</b>	920H5
	Whirlpool	337942	<b>691371</b>	8R900		Whirlpool	661570	<b>40111201</b>	935H4
	Whirlpool	3387610	<b>40111201</b>	935H4		Whirlpool	691371	<b>691371</b>	8R900
	Whirlpool	3389628	<b>349533</b>	920H5		Whirlpool	693306	<b>349533</b>	920H5
	Whirlpool	3389720	<b>40111201</b>	935H4		Whirlpool	694088	<b>349533</b>	920H5
	Whirlpool	3389728	<b>40111201</b>	935H4		Whirlpool	697388	<b>349533</b>	920H5
	Whirlpool	3392665	<b>349533</b>	920H5		Whirlpool	8181670	<b>8181670</b>	30J7MA
Whirlpool	3393999	<b>40111201</b>	935H4	Whirlpool	91261	<b>95405</b>	4LX475		
Whirlpool	3394651	<b>349533</b>	920H5	Whirlpool	95405	<b>95405</b>	4LX475		
Whirlpool	3394652	<b>3394652</b>	790H4	Whirlpool	96388	<b>96388</b>	7MR1220		
Whirlpool	3394652	<b>3394652</b>	790H4	Whirlpool	9724037	<b>9724037</b>	670J6MA		
Whirlpool	3399844	<b>349533</b>	920H5	Whirlpool	EB033ET083	<b>9724037</b>	670J6MA		

**APPLIANCE PARTS - CROSS REFERENCES**

Part No.	Jason Part No.
<b>EATON</b>	
CW151	<b>WV1</b>
CW154	<b>WV1</b>
CW50	<b>WV1</b>
CW51	<b>WV1</b>
<b>ELECTROLUX</b>	
134211400	<b>WV1</b>
5301167945	<b>1167945</b>
5308057416	<b>8057416</b>
F141779	<b>8057416</b>
5303931775	<b>DE882</b>
<b>G.E.</b>	
WH13X10024	<b>WV1</b>
WH13X58	<b>WV1</b>
WH13X59	<b>WV1</b>
WH13X60	<b>WV1</b>
WH13X66	<b>WV1</b>
WH13X71	<b>WV1</b>
WH13X72	<b>WV1</b>
WH13X75	<b>WV1</b>
WH13X76	<b>WV1</b>
WH13X78	<b>WV1</b>
WH13X81	<b>WV1</b>
WH1X10046	<b>WH1X2727</b>
WH1X2727	<b>WH1X2727</b>
WH2X10032	<b>WH2X10032</b>

Part No.	Jason Part No.
<b>G.E.</b>	
WH41X91	<b>WH41X91</b>
WH8X10018	<b>WH8X246</b>
WH8X234	<b>WH8X305</b>
WH8X281	<b>WH8X281</b>
WH8X291	<b>WH8X291K</b>
WE13X68	<b>WE13X68</b>
WE25X205	<b>WE25X205</b>
WE25X60	<b>WE25X60</b>
WE3X75	<b>WE3X75</b>
WE4X692	<b>DE382</b>
WE4X693	<b>DE382</b>
<b>GEMLINE</b>	
DE382	<b>DE382</b>
DE411	<b>691366</b>
DE412	<b>691366</b>
DE725	<b>WE25X205</b>
DE725	<b>WE3X75</b>
DE729	<b>WE13X68</b>
DE731	<b>WE25X60</b>
DE687	<b>312948</b>
DE688	<b>53-0198</b>
DE690	<b>LA1007</b>
DE692	<b>31001096</b>
DE693	<b>12001541</b>
DE694	<b>8057416</b>
DE696	<b>LA1008</b>
DE697	<b>1167943</b>

Part No.	Jason Part No.
<b>GEMLINE</b>	
DE700	<b>31001096</b>
DE702	<b>DE702</b>
DE706	<b>303373K</b>
LA189	<b>WH1X2727</b>
LP336	<b>285753</b>
LP337	<b>285753</b>
LP337HD	<b>285852</b>
LP347	<b>2-1537</b>
LP348	<b>0A4298K</b>
LP510	<b>WH8X246</b>
LP515	<b>20129</b>
LP580	<b>213015</b>
LP581	<b>216201</b>
LP585	<b>202472</b>
LP595	<b>3348552</b>
LP595	<b>WH41X91</b>
LP598	<b>93553</b>
LP602	<b>WH8X291K</b>
LP603	<b>WH8X291K</b>
LP604	<b>WH8X281</b>
LP617	<b>93770</b>
LP630	<b>356934</b>
LP631	<b>91938</b>
LP632	<b>91939</b>
LP633	<b>383727</b>
LP634	<b>359449</b>
LP655	<b>76673</b>
LP656	<b>WH8X305</b>
LP663	<b>2-4660K</b>
LP664	<b>22213057</b>
LP665	<b>213013</b>
LP666	<b>206680</b>











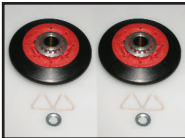

# CROSS REFERENCES

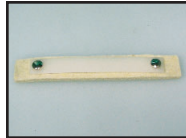
Part No.	Jason Part No.
<b>GEMLINE</b>	
LP667	<b>215234</b>
LP668	<b>215235</b>
LP669	<b>2-15447</b>
LP670	<b>1010B</b>
LP671	<b>8302</b>
LP925	<b>92815K</b>
LP932	<b>85114</b>
LP933	<b>WH1X484</b>
LP947	<b>17258</b>
LP953	<b>21365</b>
LP956	<b>212989</b>
LP989	<b>356427</b>
LP991	<b>216016K</b>
LP992	<b>214765</b>
LP993	<b>206638K</b>
<b>HORTON</b>	
343	<b>WV1</b>
525	<b>WV1</b>
526	<b>WV1</b>
639	<b>WV1</b>
325P	<b>WV1</b>
<b>MAYTAG</b>	
12001349	<b>DE382</b>
201537	<b>2-1537</b>
205613	<b>WV1</b>
206154	<b>202472</b>
206154	<b>202472</b>
206638	<b>206638K</b>
211107	<b>212989</b>
213013	<b>213013</b>
213015	<b>213015</b>
213016	<b>216201</b>
213055	<b>202472</b>
213057	<b>22213057</b>
214765	<b>214765</b>
215233	<b>215233</b>
215234	<b>215234</b>
215235	<b>215235</b>
216016	<b>216016K</b>

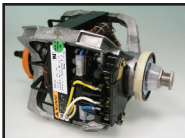
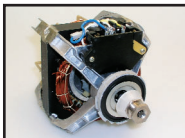
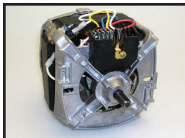
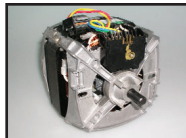
Part No.	Jason Part No.
<b>MAYTAG</b>	
216201	<b>216201</b>
285672	<b>92815K</b>
303373	<b>12001541</b>
3-3373	<b>12001541</b>
2-6154	<b>202472</b>
12001677	<b>12001677</b>
21001932	<b>WV1</b>
22002360	<b>WV1</b>
22213057	<b>22213057</b>
0A4298K	<b>0A4298K</b>
2-13055	<b>202472</b>
25-7854	<b>25-7854</b>
3-12948	<b>312948</b>
33-0085	<b>WV1</b>
33-7044	<b>WV1</b>
33-7045	<b>WV1</b>
34-0062	<b>WH1X484</b>
35-0837	<b>WH1X484</b>
35-3507	<b>WH1X484</b>
43-0219	<b>WV1</b>
53-1578	<b>31001096</b>
<b>ROBERTSHAW</b>	
81-091	<b>WH41X91</b>
81-107	<b>212989</b>
81-246	<b>WH8X246</b>
81-553	<b>93553</b>
81-690	<b>383727</b>
81-828	<b>WH8X281</b>
82-291	<b>WH8X291</b>
82-298	<b>0A4298K</b>
82-404	<b>91938</b>
82-542	<b>359449</b>
82-591	<b>WH8X291K</b>
82-814	<b>92815K</b>
82-934	<b>356934</b>
83-114	<b>85114</b>
83-258	<b>17258</b>
83-305	<b>WH8X305</b>
83-365	<b>21365</b>
83-673	<b>76673</b>
83-770	<b>93770</b>

Part No.	Jason Part No.
<b>WHIRLPOOL</b>	
17248	<b>91939</b>
18918	<b>91939</b>
54209	<b>359449</b>
62672	<b>285753</b>
63172	<b>3348552</b>
80040	<b>80040</b>
92814	<b>92815K</b>
92939	<b>91939</b>
96690	<b>383727</b>
99404	<b>91938</b>
279827	<b>279827</b>
285140	<b>285753</b>
285672	<b>92815K</b>
285743	<b>285753</b>
285753	<b>285753</b>
285805	<b>WV1</b>
285811	<b>285811</b>
285852	<b>285852</b>
297535	<b>17258</b>
341241	<b>DE702</b>
358276	<b>WV1</b>
358277	<b>WV1</b>
358992	<b>WV1</b>
363425	<b>WV1</b>
370067	<b>WV1</b>
388328	<b>WV1</b>
389248	<b>389248</b>
3348586	<b>3348552</b>
3352470	<b>285753</b>
3359818	<b>3348552</b>
3364003	<b>285753</b>
4160143	<b>WV1</b>
4160544	<b>WV1</b>
4170695	<b>WV1</b>
8318084	<b>8318084</b>
8536974	<b>DE702</b>
341241T	<b>DE702P</b>

## LOOK FOR THESE NEW JASON ITEMS IN THIS SECTION!

<b>12001541</b>		<b>DE702</b>		<b>DE702P</b>		<b>691366</b>		<b>DE382</b>		<b>WE13X68</b>	
<b>WE25X60</b>		<b>WE25X205</b>		<b>279787</b>		<b>279827</b>		<b>389248</b>		<b>3352287</b>	
<b>285852A</b>		<b>WE3X75</b>		<b>285811</b>		<b>8318084</b>		<b>80040</b>			



**ELECTROLUX**

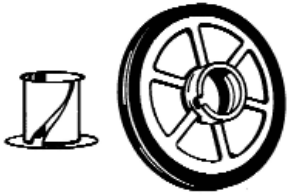

**WHEEL/TIRE ASSEMBLY**

**1167943**

Replaces: 5301167943,  
DE697

Wheel and tire assembly for 24" & 28" Frigidaire, Kelvinator and Gibson Dryers produced from 1980 through 1988.

For 5 Pack, order 1167945.

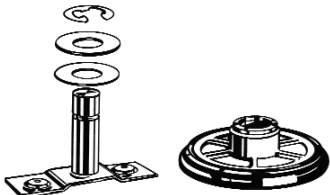

**ROLLER, COMPLETE ASSEMBLY**

**8057416**

Replaces: 5308057416,  
F14779, DE697

Center Roller with Shaft used on Frigidaire, Kelvinator and Gibson Dryers produced from 1988 to 1992.

**GENERAL ELECTRIC (GE)**

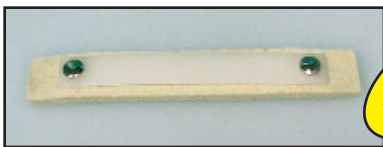

**SLIDE REPAIR**

**NEW!**

**WE13X68**

Replaces: DE729, 85-060

Glide only. Used on WE25X60 Glide Assembly. Kit includes one felt backing and two rivets for the repair of one slide.



**DRUM BEARING KIT**

**NEW!**

**WE25X205**

Replaces: DE725, WE12X62

Complete kit to replace drum shaft and bearing on gas and electric dryers.

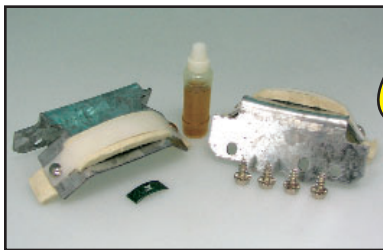

**SLIDE KIT**

**NEW!**

**WE25X60**

Replaces: DE731, 85-060

Drum slides for gas and electric dryers produced from 1960-2001.

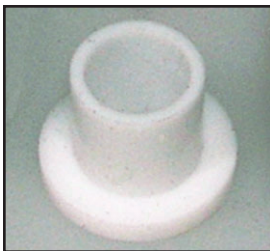

**BEARING**

**NEW!**

**WE3X75**

Replaces: DE726, De726R,  
WE12X37, 82-037

Bearing with flange eliminates the need for washers and spacers.

## MAYTAG

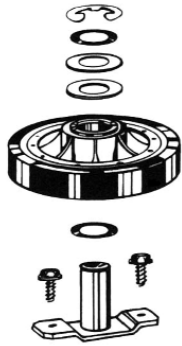

**FRONT ROLLER KIT**

**LA1007**

Replaces: DE688, DE690  
DE700, 25-7854

Original style roller kit for the front left cylinder support. Used on Herrin style Norge, Magic Chef and Norge dryers.



**REAR ROLLER KIT**

**LA1008**

Replaces: DE688, DE696  
DE692, 25-7854,  
53-1578

Original style roller kit for the front left cylinder support. Used on Herrin style Norge, Magic Chef and Norge dryers.



**ROLLER (USE 53-1578)**

**31001096**

Replaces: DE692, DE700  
53-1578, 53-0665

Roller only - used in both the LA1007 & LA1008 kits.



**DRUM ROLLER**

**303373**

Replaces: DE693

Drum roller for gas or electric Maytag dryers produced since 1984.



**ROLLER ASSEMBLY - BAG**

**303373K**

Replaces: DE706, 303373,  
3-3373, DE693

Drum roller kit. Pre-assembled and ready to install. Includes roller, shaft, washer, snap ring and nut.



**ROLLER KIT**



**12001541**

Replaces: DE693, 303373  
3-3373

303373 roller with two fiber washers.

**MISCELLANEOUS MAYTAG ROLLER PARTS**

**312535 WASHER**

**312948 SHAFT**

**313347 CURVE WASHER**

**410233 SNAP RING**

**33001443 NUT**

**25-7813 SPACER**

**25-7814 WASHER**

**25-7854 RETAINING RING**

**53-0197 SHAFT**

**53-0198 ROLLER / ROLLER SHAFT**

**UNIVERSAL**



**12001349 COIL KIT**

**NEW!**

**DE382**

Replaces: 12001349, 279834,  
5303931775, WE4X692  
& WE4X693

Coil kit used by Electrolux,  
G.E., Maytag or Whirlpool.

Used on "M" Series gas  
valves.

**WHIRLPOOL**

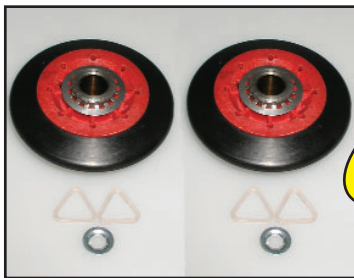

**DRUM ROLLER KIT**

**NEW!**

**DE702**

Replaces: 349241, 8536974

Heavy duty drum roller for  
Whirlpool dryer. Why stock  
both H.D. & light duty when  
ONE does the trick?

**DE702P**

Replaces: 341241T, 8536974

Two pack of DE702



**IDLER PULLEY**

**NEW!**

**691366**

Replaces: DE411, DE412

For gas or electric dryers  
using multi-ribbed belts.



**WHIRLPOOL WASHER & DRYER MOTORS**

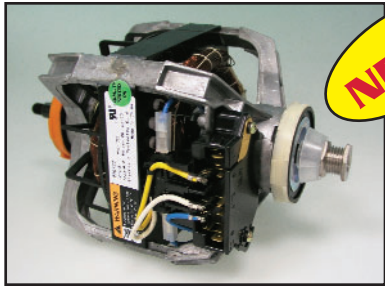

**DRYER MOTOR**

**NEW!**



Look for the "100% Quality Tested" Label!

**279787**

Replaces: 3387185, 3388237, 3388238, 3391890, 3391891, 3391893, 3395654

Dryer motor used on machines with front blower and lint filter inside the door of the machine.

Blower Shaft - 1-5/8"  
Drive Shaft - 1-1/4"  
1/3 HP, 1725 RPM

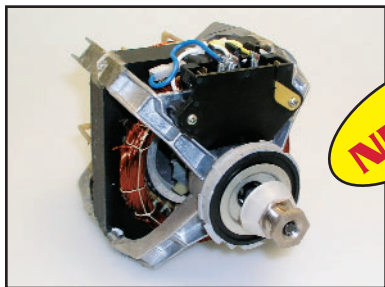

**DRYER MOTOR**

**NEW!**



Look for the "100% Quality Tested" Label!

**279827**

Replaces: 299992, 695925, 3395652

Dryer motor used on machines with rear blower and lint filter on the top of the machine.

Blower Shaft - 1-3/4"  
Drive Shaft - 1-3/4"  
1/3 HP, 1725 RPM

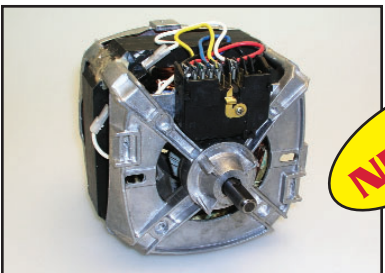

**WASHER MOTOR**

**NEW!**



Look for the "100% Quality Tested" Label!

**389248**

2-speed washer motor used on direct drive machines since 1984.

1/2 HP, 1140/1725 RPM

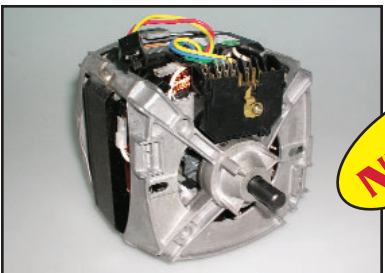

**WASHER MOTOR**

**NEW!**









Look for the "100% Quality Tested" Label!

**3352287**

3-speed washer motor used on direct drive machines.

1/2 HP, 850/1140/1725 RPM

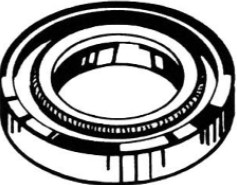
**GENERAL ELECTRIC (GE)**

 <p><b>GE STRAP DAMPING</b></p>	<p><b>WH1X2727</b> Replaces: WHX10046, LA189</p>	<p>Dampening (Bungee) Strap used from 1996 to current.</p>
 <p><b>FOOT PAD</b></p>	<p><b>WH1X484</b> Replaces: 34-0062, 35-0837, 35-3507, LP933</p>	<p>Leveling leg pad, 1-1/4" diameter.</p>
 <p><b>TUB SEAL</b></p>	<p><b>WH2X10032</b></p>	<p>Tub seal for G.E. washers manufactured from 1995 through current.</p>
 <p><b>TUB TO PUMP HOSE (GE)</b></p>	<p><b>WH41X91</b> Replaces: LP595, 81-091</p>	<p>Tub to pump hose used from 1959 through 1995.</p>
 <p><b>GE STAR BOOT</b></p>	<p><b>WH8X246</b> Replaces: WH8X10018, 81-246, LP510</p>	<p>Molded rubber tub boot used from 1961 through 1995. Jason polished molds supplies a superior replacement.</p>
 <p><b>GE LOWER SHAFT SEAL</b></p>	<p><b>WH8X281</b> Replaces: LP604, 81-828</p>	<p>Lower transmission seal used on models from 1957 to 1995.</p>
 <p><b>TOP SHAFT SEAL</b></p>	<p><b>WH8X291K</b> Replaces: LP602, LP603, 82-291, 82-591, WH8X291</p>	<p>Kit includes WH8X291 Seal &amp; WH1X1986 Agitate Support.</p>
 <p><b>GASKET</b></p>	<p><b>WH8X305</b> Replaces: LP656, 83-305, WH8X234</p>	<p>Outer tub gasket used from 1971 to 1995.</p>

## MAYTAG

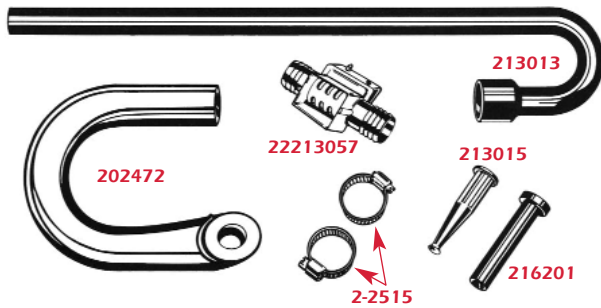

**2-4660K MAYTAG INJECTOR KIT**  
Side Mount injection fill assembly for older models

**2-4660K MAYTAG INJECTOR KIT**

Replaces - LP663

**213013 (Hose)**

Replaces - LP665

**213015 (Nozzle)**

Replaces - LP580

**216201 (Valve)**

Replaces - 213016, LP581

**202472 (Tube)**

Replaces - LP585, 213055, 2-13055, 206154

**22213057 (Sleeve)**

Replaces - 213057, LP664

**2-2515 (Clamp)**

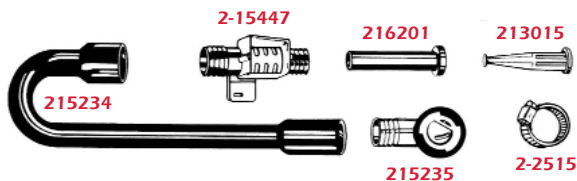

**206680 MAYTAG INJECTOR KIT**  
Bottom Mount injection fill assembly for later models

**206680 MAYTAG INJECTOR KIT**

Replaces - LP666

**215233 (Seal)**

**215234 (Injector Hose)** Replaces - LP667

**215235 (Injector Seal)** Replaces - LP668

**216201 (Valve)** Replaces - LP581, 213016

**2-2515 (Clamp)**

**2-15447 (Sleeve)**

Replaces - LP669

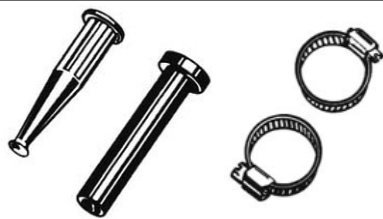

**12001677 MAYTAG INJECTOR VALVE KIT**

**12001677 MAYTAG INJECTOR VALVE KIT**

**213015 (Nozzle)** Replaces - LP580

**216201 (Valve)** Replaces - 213016, LP581

**2-2515 (Clamp)**

**Maytag Injector Parts are Available Individually**









Check out Jason's brand new website for new product information and the latest news.

[www.jasonindustrial.com](http://www.jasonindustrial.com)

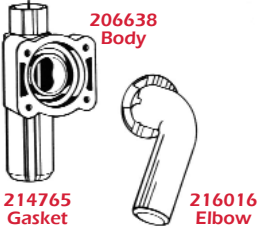



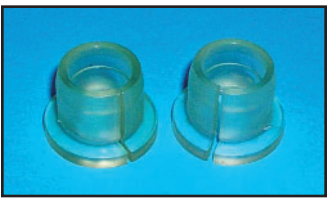



**MAYTAG**

 <p><b>GASKET, SIPHON BREAK ELBOW WITH WASHER</b></p>	<p><b>214765</b> Replaces: LP992</p> <p><b>206638K</b> Replaces: 206638, LP993</p> <p><b>216016K</b> Replaces: 216016, LP991</p>	<p><b>214765 -</b> Gasket for 206638 siphon break.</p> <p><b>206638K -</b> Replacement Siphon Break kit, includes 206638 body, 214765 Gasket, and clamp.</p> <p><b>216016K -</b> Elbow with Gasket</p>
 <p><b>FOOT PAD</b></p>	<p><b>WH1X484</b> Replaces: 34-0062, 35-0837, 35-3507</p>	<p>Leveling leg pad, 1-1/4" diameter.</p>
 <p><b>MOUNTING STEM SEAL</b></p>	<p><b>2-1537</b> Replaces: LP347, 201537</p>	<p>Seal only for Maytag 22204012 stem seal kit.</p>
 <p><b>SHAFT SEAL</b></p>	<p><b>0A4298K</b> Replaces: LP348, 82-298</p>	<p>Replacement for Maytag agitator drive shaft on both Wringer and Automatic Washers. Pre-lubricated with fabric seal face and inner spring.</p>
 <p><b>MAYTAG HOSE</b></p>	<p><b>212989</b> Replaces: LP956, 81-807, 211107</p>	<p>Replaces 15" tub to pump hose on Maytag washers.</p>
 <p><b>MOTOR ISOLATOR</b></p>	<p><b>22003329</b></p>	<p>Isolator only used with Neptune washer belt 62722870. See part number 12001788 for 2-isolators and 1-belt.</p>
<p><b>SPEED QUEEN</b></p>		
 <p><b>TUB BOOT</b></p>	<p><b>20129</b> Replaces: LP515</p>	<p>Replaces molded rubber boot for seal between outer tub and main bearing. For solid tub automatic washers.</p>

## WHIRLPOOL

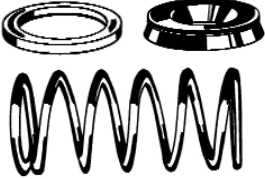
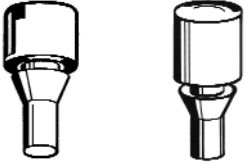
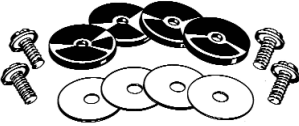
 <p><b>WHIRLPOOL COUPLER</b></p>	<p><b>285753</b>                  Replaces: LP336, LP337,                  62672, 285140, 285743,                  3352470, 3364003</p>	<p>Improved material construction lasts longer and performs better. Fits direct drive washers.</p>
 <p><b>"NEW" HD COUPLER</b></p>	<p><b>285852A</b>                  Replaces: LP337HD</p>	<p>Built in durability for extended performance and life. Heavy duty, with metal stabilizer, for direct drive. Now with metal insert to prevent rounding from motor shaft.</p>
 <p><b>CAM KIT</b></p>	<p><b>285811</b>                  Replaces: LP285</p>	<p>Cam Kit includes 285746, 285587 and 3348855 in one convenient kit.                   Standard kit - 2-1/4" tall.</p>
 <p><b>SPIN PINION SEAL</b></p>	<p><b>356427</b>                  Replaces: LP989</p>	<p>Replacement secondary seal for main drive shaft on belt drive Washers.</p>
 <p><b>WHIRLPOOL UPPER SEAL</b></p>	<p><b>356934</b>                  Replaces: LP630, 82-934</p>	<p>Upper spin tube seal for belt drive washers.</p>
 <p><b>WHIRLPOOL LOWER SEAL</b></p>	<p><b>359449</b>                  Replaces: LP634, 82-542,                  54209</p>	<p>Lower spin tube seal for belt drive washers.</p>
 <p><b>TUB CENTER GROMMET</b></p>	<p><b>383727</b>                  Replaces: LP633, 81-690, 96690</p>	<p>Replaces center post gasket used on belt drive Washers.</p>
 <p><b>LID SWITCH</b></p>	<p><b>8318084</b></p>	<p>Replacement lid switch used on late model top load washing machines.</p>

**WHIRLPOOL**

 <p><b>SPRING/SEAL KIT</b></p>	<p><b>92815K</b> Replaces: LP925, 82-814, 92814, 285672</p>	<p>Spring seal kit for belt drive Washers.</p>
 <p><b>17258      93770</b> <b>RUBBER BUMPER</b></p>	<p><b>17258</b> Replaces: LP947, 83-258, 279535</p>	<p>Molded rubber bumper packed 50 per bag.</p>
	<p><b>93770</b> Replaces: LP617, 83-770</p>	<p>Our most popular molded rubber bumper for automatic washers. Packaged 50 to poly bags.</p>
 <p><b>TUB REPAIR KIT</b></p>	<p><b>76673</b> Replaces: LP655, 83-673</p>	<p>All the parts needed to repair leakage around Whirlpool tub mounting bolts. Packed in poly bag.</p>
 <p><b>DOG KIT</b></p>	<p><b>80040</b> Replaces: LP338</p>	<p>Nylon agitate dogs with sharp teeth for extended ratcheting action.</p>
 <p><b>FOOT PAD</b></p>	<p><b>85114</b> Replaces: LP932, 83-114</p>	<p>Leveling leg pad, 1-1/8" diameter.</p>
 <p><b>SPIN TUBE SEAL</b></p>	<p><b>91938</b> Replaces: LP631, 82-404, 92404</p>	<p>Steel insert, rubber covered for spin tubes on all belt drive automatic washers.</p>
 <p><b>AGITATOR SHAFT SEAL</b></p>	<p><b>91939</b> Replaces: LP632, 17248, 18918</p>	<p>Steel insert, rubber covered seal for agitator shafts on all belt drive automatic washers.</p>

Part numbers and illustrations intended solely for identification. Items offered for sale are not represented to be manufactured by the company that built the appliance.



**WHIRLPOOL**



**TUB GROMMET**

**93553**

Replaces: LP598, 81-553

Outer tub to bottom trap or lint filter for belt drive automatic washers.



**PUMP HOSE**

**3348552**

Replaces: LP595, 63172, 3348586, 3359818

Pump to drain hose.

**INLET HOSE & ACCESSORIES**

**QUALITY REPLACEMENT HOSE FOR ALL WASHERS & DISHWASHERS**

**3805FFB-2**

**Diameter of Hose**  
12 - 1/2" hose  
38 - 3/8" hose

**Type of Fitting**  
EE - Female 90° to Female 90°  
FF - Female to Female  
FE - Female to 90° Female  
FM - Female to Male

**Special Pack Qty.**  
-2 = 2 pack in bag  
-75 = 75 bulk box

**Hose Length (In Feet)**

01 - 8"	06 - 6'
02 - 2'	08 - 8'
03 - 3'	10 - 10'
04 - 4'	12 - 12'
05 - 5'	15 - 15'

\*Custom hose lengths available on request.

**Special Additions**

- B - Bagged with Washers
- BR - Solid Brass Ends
- BRB - Solid Brass Ends, Bagged with Washers
- BT - Tagged for Label
- G - (GHT) Garden Hose Thread to (BSP) British Standard Pipe Thread
- PV - Poly Braided Hose with Nylon Ends
- PB - Poly Braid Hose

**INLET (3/8" I.D.) HIGH PRESSURE HOSE**

- Burst strength test of 800 Psi (cold water), 600 Psi (hot water)
- Double crimped ends provide added fitting strength



**FEMALE x FEMALE**



**FEMALE x 90° ELBOW**



**MALE x FEMALE**

Length	Jason Part No.	Jason Part No.	Jason Part No.
3'	<b>3803FF</b>	<b>3803FE</b>	<b>3803MF</b>
4'	<b>3804FF</b>	<b>3804FE</b>	<b>3804MF</b>
5'	<b>3805FF</b>	<b>3805FE</b>	<b>3805MF</b>
6'	<b>3806FF</b>	<b>3806FE</b>	<b>3806MF</b>
8'	<b>3808FF</b>	<b>3808FE</b>	<b>3808MF</b>
10'	<b>3810FF</b>	<b>3810FE</b>	<b>3810MF</b>
12'	<b>3812FF</b>	<b>3812FE</b>	<b>3812MF</b>
15'	<b>3815FF</b>	<b>3815FE</b>	

**FOR COMMERCIAL LAUNDRY 1/2" HOSE ● UNIMAC**

1/2" x 4'	<b>1204FF</b>		
1/2" x 4'	<b>1205FF</b>		
1/2" x 4'	<b>1206FF</b>		

**BAGGED HOSE & BSP THREAD**



**SPECIAL 2-PACK HOSE BAGGED WITH WASHERS**

Length	Jason Part No.
4'	<b>3804FFB-2</b>
5'	<b>3805FFB-2</b>
6'	<b>3806FFB-2</b>

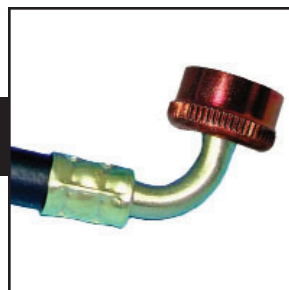

**BSP - METRIC THREAD FEMALE W/ 90° CONNECTOR x STANDARD FEMALE THREAD**

Length	Jason Part No.
4'	<b>3804FEG</b>
5'	<b>3805FEG</b>
6'	<b>3806FEG</b>

## PVC INLET HOSE

- 1000 Psi Burst
- Nylon & Brass Ends
- Built-In Washers
- 90° Connection for Washer End

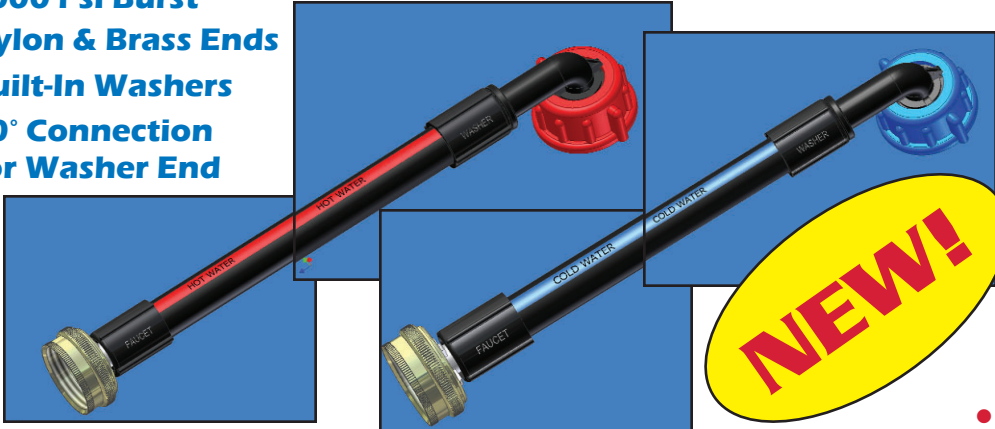

- Same High-Performance PVC Hose
- Includes Sight Window for Screen Inspection

**2 Per Pack - (1 Hot/1 Cold)**

5'	<b>3805FEPV2</b>	<b>3805FESC2</b>
6'	<b>3806FEPV2</b>	

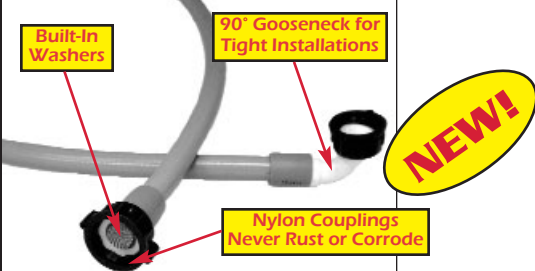

**3804FEPV (4')**  
**3805FEPV (5')**  
**3806FEPV (6')**

Budget PVC hoses with nylon ends. 90° connector on washer hook-up and built-in washers.  
 Burst Pressure: 1000 Psi - cold  
 600 Psi - hot



**HYP-38**  
 Replaces: HP403

3/8" single male and two female fittings. For use to connect single inlet to washing machine inlet valve.



**1455C**  
 Replaces: LA173

Attaches directly to mixing valve when only one source of water supply is available. One male and two female 3/4" thread connections.

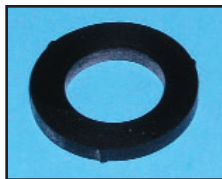

**3/4" HOSE WASHER - 100 PER BAG**

Black Neoprene hose washer, resistant to hot water aging.



**RW79SC (25 pack)**  
**RW79SC-100 (100 pack)**  
**HOSE/SCREEN WASHER**

Hose washer with screen.



**SSD WASHER DRAIN HOSE & ACCESSORIES**



**SSD-6PF POLY-FLO UNIVERSAL DRAIN HOSE**

With molded adapter to fit 1", 1-1/8" and 1-1/4" outlets. Adjustable plastic gooseneck allows hose length to be shortened to any length while keeping a perfect "U" for the hose outlet. Size 1" x 6'

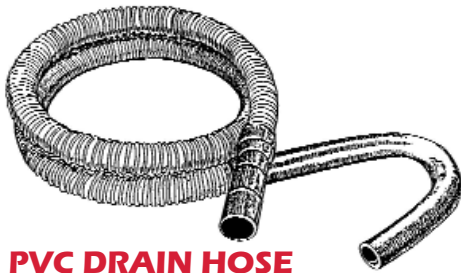

**PVC DRAIN HOSE**

The industry's top selling universal drain hose. Molded gooseneck, and adaptable triple outlet connector fits 1", 1-1/8" and 1-1/4" outlets. The poly-flo hose is kink-resistant with a smooth interior wall that insures an unrestricted water flow. Available in 6' and 8' lengths.

Part No.	Size	Connector
<b>SSD-6</b>	1" x 6'	1", 1-1/8", 1-1/4"
<b>SSD-8</b>	1" x 8'	1", 1-1/8", 1-1/4"

SSD-6B & SSD-8B Poly-Flo Bagged Drain Hoses are available individually packaged.

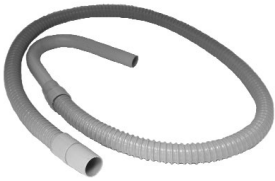

**4'/6'/8' G.E. DRAIN HOSE**



**WH16X513 CLIP FOR G.E. DRAIN HOSE**

**SSD-4GE  
SSD-6GE  
SSD-8GE**

Replaces: WH41X10096, WH41X367

Upgrade to the SSD Poly-Flow design adapted to fit G.E. washing machines manufactured from 1996 to current. Available in 4', 6' and 8' lengths.

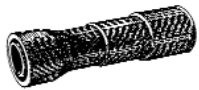

**Part No. CUFA**  
**Triple connector**  
1", 1-1/8", 1-1/4"  
for SSD Hose



**Part No. CUF E**  
**Elbow connector**



**Part No. CUFGE**  
**G.E. connector**



**Part No. GNB**  
**1" I.D. Gooseneck**  
for SSD Hose



**Part No. SSD-50**  
**50' Bulk SSD Hose**

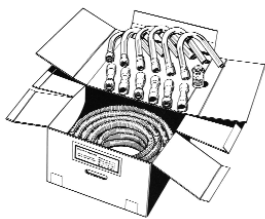

**SSD-50K SERVICE KIT**

Make multiple lengths of SSD style hose. **SSD-50K Service Kit** contains SSD-50, 6 ea. GNB Gooseneck, 6 ea. CUFA Connector and 1 can of PVC cement. Caution - Many wash machines have a maximum pumping capability based on drain length and rise. Check with the manufacturer's specifications before extending a drain hose beyond 8'.



**WD24X1003 DIRECT REPLACEMENT DISHWASHER HOSE**

Direct replacement for G.E. Dishwasher Drain Hose. Sink end is expanded to fit both disposal or can be cut off to fit sink tee. 77" long, fits 1/2" I.D. pump outlet.



**SSDW-7 UNIVERSAL DISHWASHER DRAIN HOSE**

5/8" I.D. x 7' hose with universal four step connector on both ends.  
Connector - 5/8", 3/4", 1-1/4"



**Part No. SSDW-100**  
**5'8" I.D. x 100' hose**

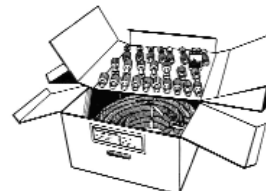

**SSDW-K SERVICE KIT**

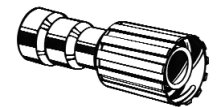



**Part No. DWLC**  
**Universal Dishwasher Drain Connector**

**SSDW-K Service Kit** contains SSDW-100 Hose, 24 DWLC Connectors and one can of PVC cement.

**RUBBER DRAIN HOSE**

 <p><b>UNIVERSAL DRAIN HOSE</b></p>	<p><b>63155</b> Replaces: 2047</p>	<p>5-1/2' universal drain hose with molded gooseneck and 90° expanded elbow. Expanded elbow fits 1", 1-1/8" and 1-1/4" diameter outlets.</p>
 <p><b>15/16" X 44" DRAIN HOSE</b></p>	<p><b>96743</b> Replaces: 91183, 81-746, LP593</p>	<p>Direct Replacement for Whirlpool. 15/16" x 30" Drain hose.</p>
 <p><b>OUTLET HOSE W/ LABEL</b></p>	<p><b>96746</b> Replaces: 91182, 81-746, LP592</p>	<p>Direct Replacement for Whirlpool. 15/16" x 31"</p>
 <p><b>NON-PRESSURE BULK DRAIN HOSE</b></p>	<p><b>B-150</b> Replaces: B15</p>	<p>Black smooth synthetic rubber. 15/16" I.D. x 50'. Packaged in 50' carton</p>
 <p><b>PRESSURE-RATED DRAIN HOSE</b></p>	<p><b>B-5050</b> <b>B-6350</b> Replaces: B55, B635</p>	<p>Can be used for dishwashing or all plumbing connections. Packaged in 50' carton.</p> <p><b>B-5050</b> - 1/2" x 50' <b>B-6350</b> - 5/8" x 50'</p>
 <p><b>HOSE MENDER (1")</b></p>	<p><b>HM101</b> Replaces: LA101</p>	<p>Joins all 15/16" and 1" I.D. drain hoses. Use with hose clamps.</p>

**GARBAGE DISPOSAL PARTS**

	<p><b>UDA125</b> (Replaces: HP422) <b>UNIVERSAL DRAIN ADAPTER</b></p>	<p>Universal Tail Piece for garbage disposal to undersink drain trap. PVC hose allows adjustable length in any direction from 12" to 32" long.</p>
	<p><b>8302</b> (Replaces: 30103, LP671) <b>UNIVERSAL SPLASH GUARD</b></p>	<p>Replaces In-Sink-Erator, Emerson, Sears, True Value, Frigidaire, Westinghouse, Roper, Dayton, Wolverine Brass.</p>
 <p><b>1010A 1010B</b> <b>SPLASH GUARD</b></p>	<p><b>1010A</b> (Replaces: 9959) <b>1010B</b> (Replaces: 9963, 30102, LP670)</p>	<p>Replaces In Sink Erator 333/SS, 77, Classic. Emerson E-100, E-120, Sears 6040, 6050, 6070, 6072. Replaces In Sink Erator Badger 1, Badger V, 333. Emerson E-10, E-20, E-30, E-80. Sears 6010, 6011, 6012, 6013, 6030.</p>





# Jason Industrial Inc.®

For catalog information, see [www.jasonindustrial.com](http://www.jasonindustrial.com)

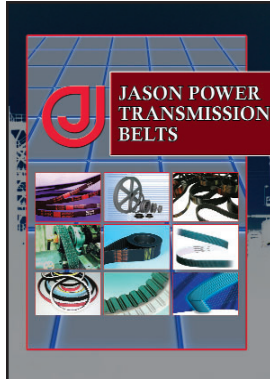

**Power Transmission Belts**  
Catalog JB-8



**Urethane Power Transmission Belts**  
Catalog UB-4

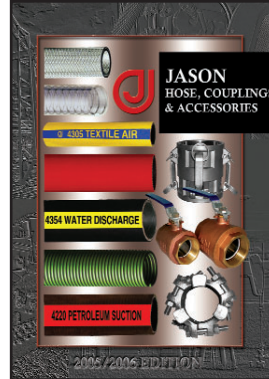

**Industrial Hose, Couplings & Accessories**  
Catalog HC-8

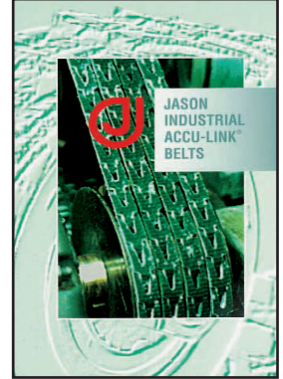

**Accu-Link Belts**  
Catalog AL-4



**Multi-Plus Dual Brand V-Belts / Light & Heavy Duty Sheaves & Bushings**  
Catalog MPSB-1

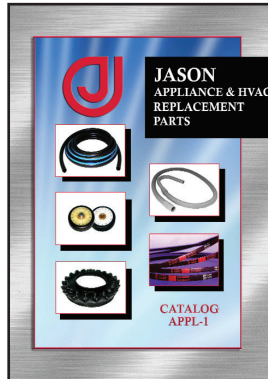

**Appliance & HVAC Replacement Parts**  
Catalog APPL-2



**Tiger Horsepower Synchronous Belts**

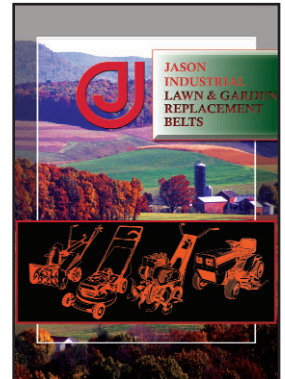

**Lawn & Garden Belts**  
Catalog LG-1007

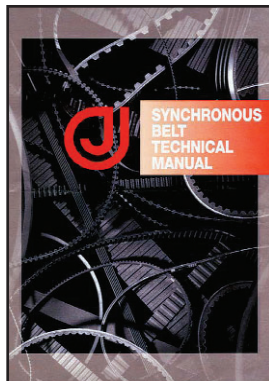

**Synchronous Belt Technical Manual**  
TM-2



**Autotension Self-Tensioning Belt**



**Made to Order Timing Belts**

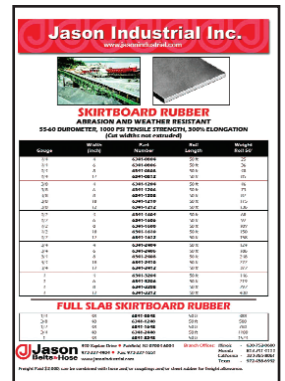

**Skirtboard Rubber**

**Your Industrial Rubber & Iron Solution!**

# **Jason Industrial Appliance Replacement Parts**



## **Terms & Conditions of Sales**

### **Terms**

Net 30 days unless otherwise specified by our Credit Department. We reserve the right to withhold shipments on order from accounts with unpaid balances of 45 days or older.

### **Freight Allowances**

All shipments are F.O.B. point of shipment. For Freight Allowance, please refer to price schedule.

### **Prices**

All prices and quotations are subject to change without notice and are accepted subject to our ability to fill them at prices in effect at time of shipment.

### **Minimum Order**

Individual orders must meet a minimum Net value of \$25.00 for all Jason products ordered, or the balance will be considered a service charge.

### **Returned Goods**

Merchandise purchased from us may be returned only with our written approval with transportation charges prepaid. If, after our inspection, credit or adjustment is allowed, transportation charges will be refunded. Return of non-defective material will be subject to a handling charge.

### **Warranty**

Jason products are warranted to be free of defects in workmanship and material, but are not guaranteed for any specific length of time or measure of service. Such liability under this warranty is limited to the purchase price only of the product(s) and does not include other liability direct or indirect nor consequential damages of any nature whatsoever. Claims on account of defect in quality of the said product shall be deemed to be waived by the buyer, unless made in writing within thirty (30) days after date of delivery. The Company will, at its own option, make replacements or issue credit after charging for service already rendered by the defective merchandise.

## **Customer Service**

**1-800-527-1247  
(Fax) 1-800-527-2217**

---

## **Jason Locations**

**Corporate Office  
Jason Industrial Inc.**  
340 Kaplan Drive  
Fairfield, NJ 07004  
973-227-4904  
FAX: 973-227-1651

**Branch Offices & Warehouses  
Jason Industrial Inc.**  
258 S. Westgate Drive  
Carol Stream, IL 60188-2243  
630-752-0600  
FAX: 630-752-0680

**Jason Industrial Inc.**  
3724 East 26th Street  
Los Angeles, CA 90023  
323-265-8061  
FAX: 323-265-0813

**Jason Industrial Canada Ltd.**  
9135 Cote De Liesse  
Dorval, Quebec H9P-2N9  
514-631-6781  
FAX: 514-631-7408

---

## **Other Jason Locations**

Irving, Texas  
Tampa, Florida  
Sorocaba - Sao Paulo Brazil  
Mississauga, Ontario Canada  
Edmonton, Alberta Canada  
Azcapotzalco, Mexico  
United Kingdom

---

**Visit us online at  
[www.jasonindustrial.com](http://www.jasonindustrial.com)**